



Cast Marble Solutions for Your Showers



66" x 36"-8" Trench Drain LH or RH Shower Base

SB66x36-8TD-XH-LC

Est. Weight: 160 lbs (72 kg) IMI LiteCast™

TECHNICAL SPECIFICATIONS

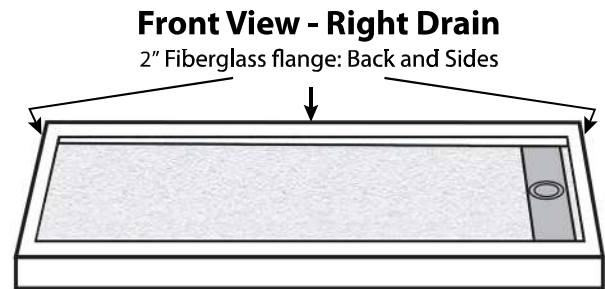
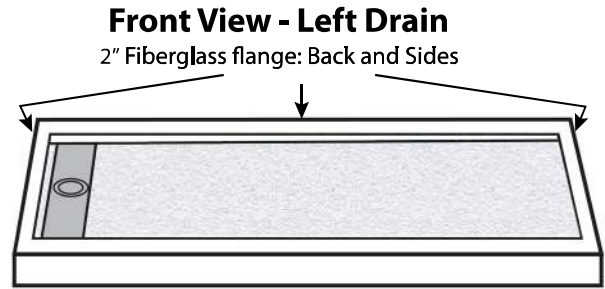
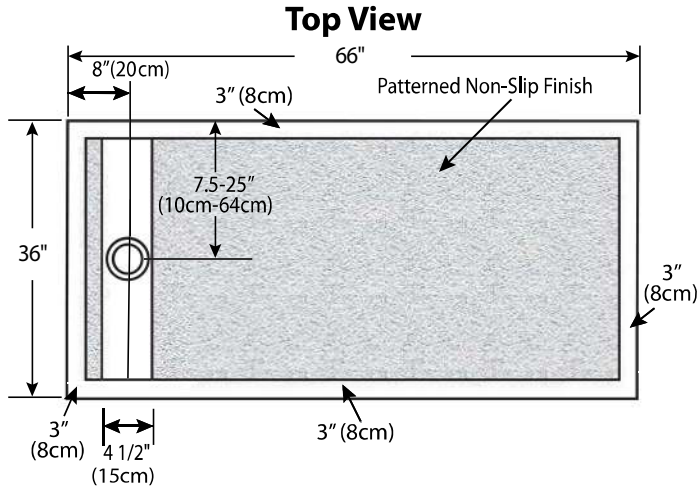

Side View of Curb

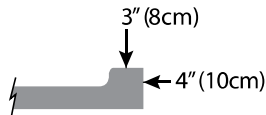

Drain Details: (U.S.)

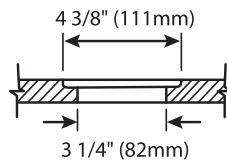

Drain Cover

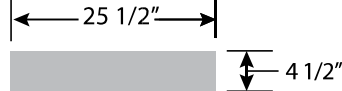

Flange Details: (U.S.)

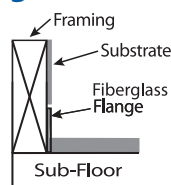

Standard Features:

- Solid one-piece construction
- Pre-leveled - rests on subfloor
- Mold and mildew resistant
- Bacteria resistant
- Textured non-slip finish
- Abrasion resistant gelcoat surface
- Stainless steel trench drain cover

Suggested Drains:

- Solvent Weld type fitting similar to Oatey Part No. 42097
- Compression type "No-Caulk" fitting similar to Oatey Part No. 42099

Specifications:

- Drain Location: Center of drain measures 8" from side of pan
7.5-25" from backwall
- Flange: Fiberglass
- Trench: 4 1/2" width

Note: Base dimensions may vary +/- 1/8"

Our products comply with one or more of the following: IAPMO, ANSI, HUD, NAHB, NHQ

22 42 23 (Div 22)

Revised: 2018.09.12

© 2018 Copyright IMI International Marble Industries, Inc.

