



# 60" x 36"-8" Trench Drain LH or RH Shower Base

SB60x36-8TD-XH-LC

Est. Weight: 170 lbs. (31.7kg) IMI LiteCast™

TECHNICAL SPECIFICATIONS

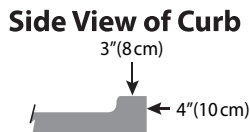
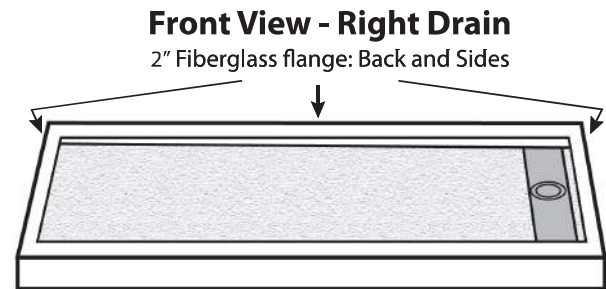
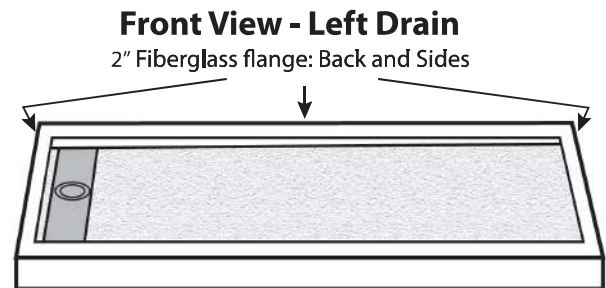
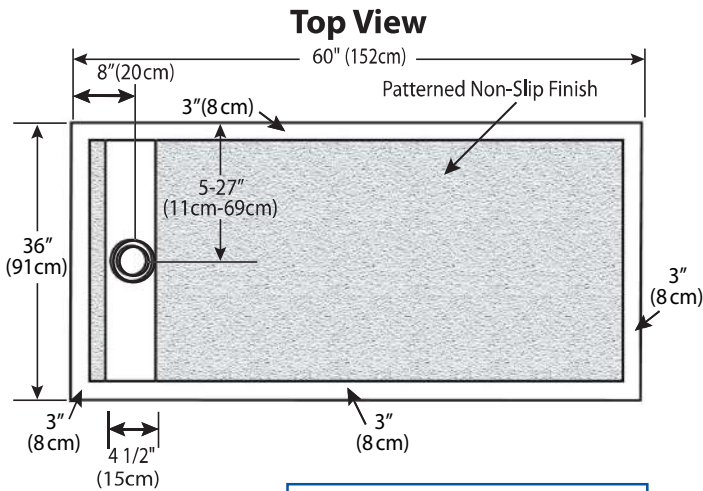

### Drain Details: (U.S.)

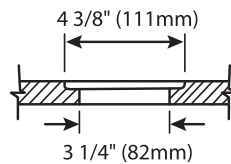

### Flange Details: (U.S.)

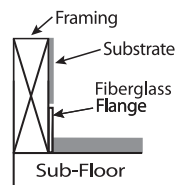

## Standard Features:

- Solid one-piece construction
- Pre-leveled - rests on subfloor
- Mold and mildew resistant
- Bacteria resistant
- Textured non-slip finish
- Abrasion resistant gelcoat surface
- Stainless steel trench drain cover

## Specifications:

- Size: 60" x 36" Size
- Drain Location: Center of drain measures 8" from side of pan  
7-29" from backwall
- Flange: Fiberglass
- Trench: 4 1/2" width

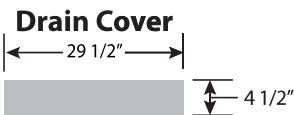

Note: Base dimensions may vary +/- 1/8"

## Suggested Drains:

- Solvent Weld type fitting similar to Oatey Part No. 42097
- Compression type "No-Caulk" fitting similar to Oatey Part No. 42099

22 42 23 (Div 22)

Revised: 2018.06.20

© 2018 Copyright IMI International Marble Industries, Inc.

Our products comply with one or more of the following: IAPMO, ANSI, HUD, NAHB, NHQ

