



60" x 32" - 4" Trench Drain LH or RH Shower Base

SB-60x32-4TD-XH-LC

Est. Weight: 165lbs (74kg) IMI LiteCast™

TECHNICAL SPECIFICATIONS

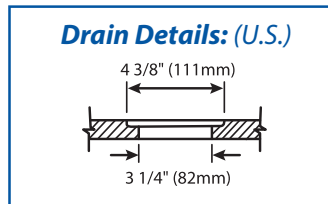
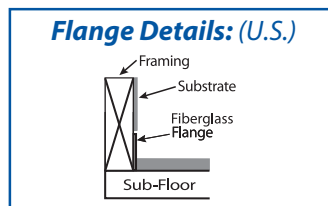
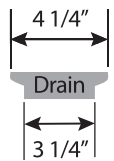
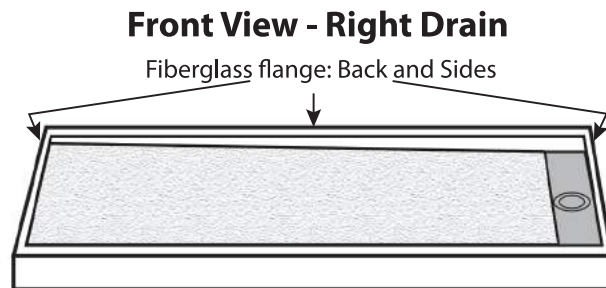
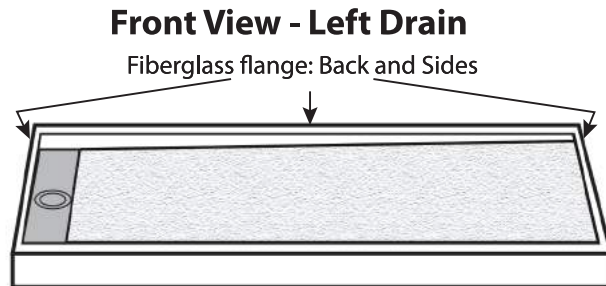
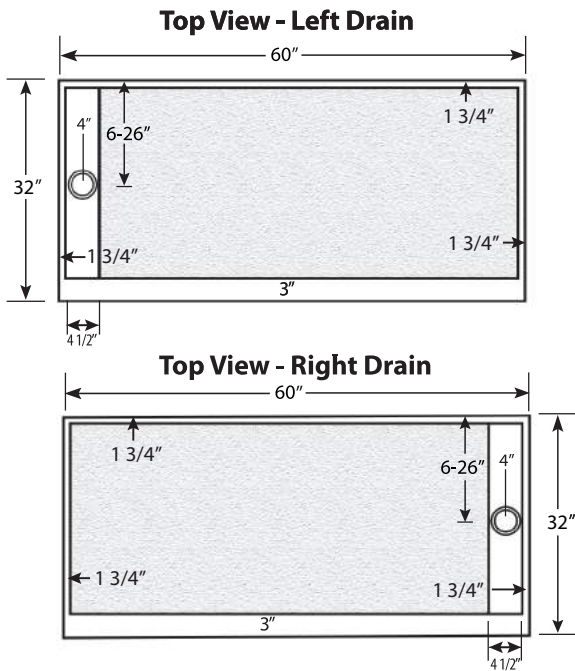

Side View of Curb

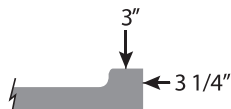

Drain Cover



Note: pan dimensions vary +/- 1/8"

Standard Features:

- Solid one-piece construction
- Pre-leveled - rests on subfloor
- Mold and mildew resistant
- Bacteria resistant
- Textured non-slip finish
- Abrasion resistant gelcoat surface
- Stainless steel trench drain cover

Specifications:

- Size: 60" x 32" Size
- Drain Location: Center of drain measures 4" from side of pan 6-26" from backwall
- Flange: Fiberglass
- Trench: 4 1/2" width

Suggested Drains:

- Solvent Weld type fitting similar to Oatey Part No. 42097
- Compression type "No-Caulk" fitting similar to Oatey

Typical CSI Codes: 22 42 23 (Div 22)

Revised 2018.06.21

© 2018 Copyright IMI International Marble Industries, Inc.

* Also available in IMI ProCast™

