



Cast Marble Solutions for Your Showers



60" x 32"-8" Trench Drain LH or RH Shower Base

SB60x32-8TD-XH-LC

Est. Weight: 160 lbs (72 kg) IMI LiteCast™

TECHNICAL SPECIFICATIONS

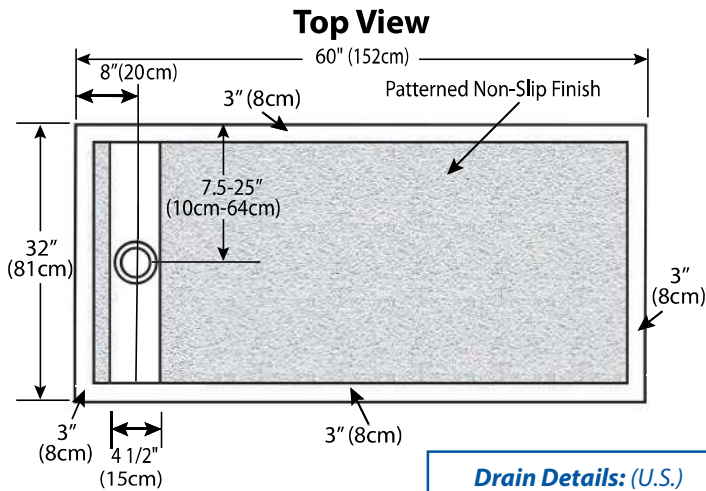

Side View of Curb

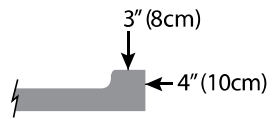

Drain Details: (U.S.)

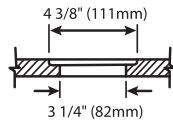

Flange Details: (U.S.)

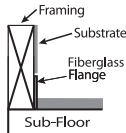

Drain Cover

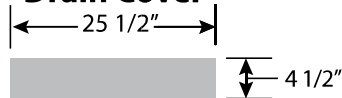

Note: pan dimensions vary +/- 1/8"

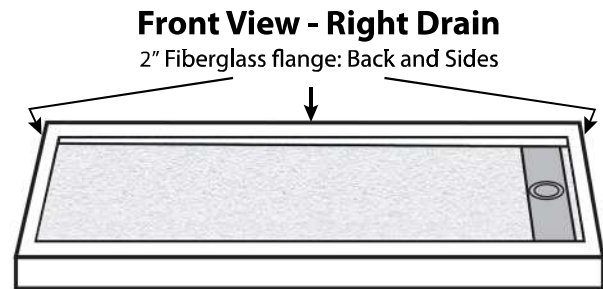
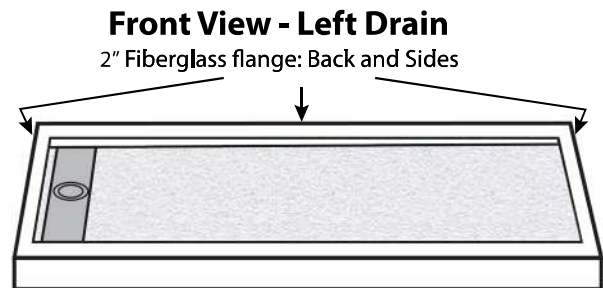

Standard Features:

- Solid one-piece construction
- Pre-leveled - rests on subfloor
- Mold and mildew resistant
- Bacteria resistant
- Textured non-slip finish
- Abrasion resistant gelcoat surface
- Stainless steel trench drain cover

Specifications:

- Size: 60" x 32" Size
- Drain Location: Center of drain measures 8" from side of pan
7.5-25" from backwall
- Flange: Fiberglass
- Trench: 4 1/2" width

Note: Base dimensions may vary +/- 1/8"

Our products comply with one or more of the following: IAPMO, ANSI, HUD, NAHB, NHQ

22 42 23 (Div 22)

Revised: 2018.06.20

© 2018 Copyright IMI International Marble Industries, Inc.



INTERNATIONAL MARBLE INDUSTRIES, INC.

| 304 Bell Park Drive |

Woodstock, GA 30188 |

770.928.2252 |

www.IMItoday.com