

SB54x36-SSB-LC

inches

54 X 36 STANDARD SHOWER BASE WITH CENTER DRAIN

IMI LITECAST™

Exterior Dimensions: 54W x 36D

Note: Base dimensions may vary +/- 1/8"

* Also available in IMI ProCast™

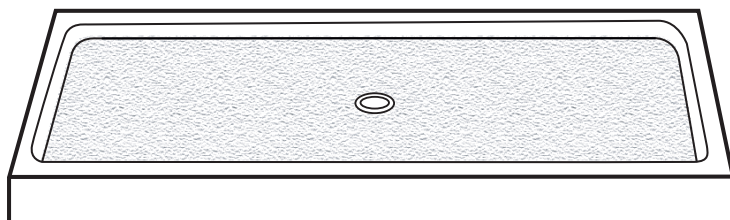

FEATURES

- Solid one-piece construction
- Pre-leveled, rests on subfloor
- Mold and mildew resistant
- Bacteria resistant
- “Grout-free” and non-porous
- Stain resistant and easy to clean
- Water proof and leak proof

STANDARDS AND RATINGS

- Typical CSI Code: 22 42 23 (Div 22)
- ANSI
- ASTM (Fire Rating)
- MAS Certified Green

Code compliant when fully equipped and installed according to guidelines.

Material to be stacked on pallets.

COLOR & TRIM OPTIONS

| Standard Color | Code |
|----------------|------|
|----------------|------|

| | |
|-------|----|
| White | SW |
|-------|----|

| Optional Color | Code |
|----------------|------|
|----------------|------|

| | |
|------------|----|
| Cream | SC |
| Ivory | SI |
| Warm White | WW |

Additional custom colors available.



Cast Marble Solutions



SB54x36-SSB-LC

54 X 36 STANDARD SHOWER BASE WITH CENTER DRAIN

IMI LITECAST™

Top View

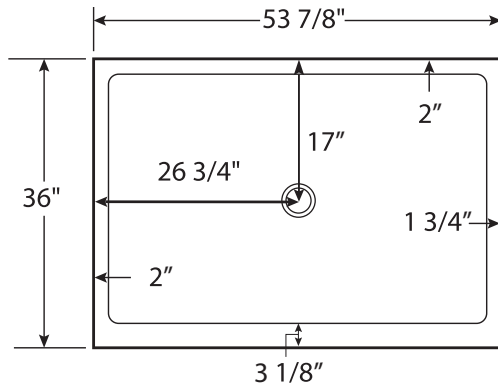

Front View

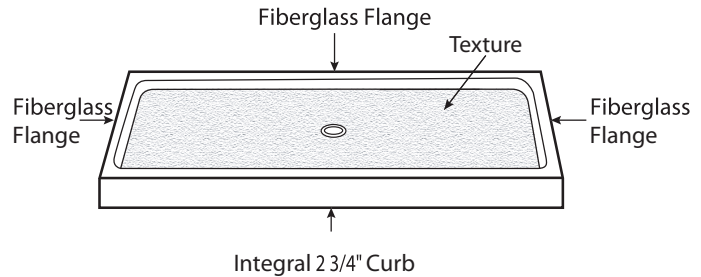

Drain Details: (U.S.)

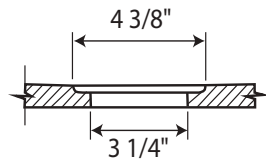

Flange Details: (U.S.)

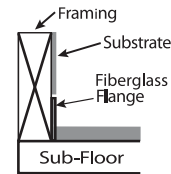



FEATURES Dimensional Tolerance $\pm 1/8$ ". Dimensions needed for site preparation should be measured from the unit. American Bath Group assumes no responsibility for preparatory work.

| Type and Model # | Material | Shower Base | Pieces |
|-----------------------------|-------------|---------------------------|--------|
| Shower Base #SB54x36-SSB-LC | Cast Marble | Anti-Slip/Textured Finish | 1 |

DIMENSIONS

| Specifications | inches |
|--------------------|--------|
| Shower Base Depth: | 36 |
| Shower Base Width: | 53 7/8 |
| Curb Height: | 2 3/4 |

SUGGESTED DRAINS

| Image | Description |
|---|---|
|  | Solvent Weld type fitting similar to Oatey Part No. 42097 |
|  | Compression type "No-Caulk" fitting similar to Oatey Part No. 42099 |

Rev. 04.12.21