

SB62x38-RI-5TD-LC

inches

62 X 38 ADA ROLL-IN W/5" TRENCH DRAIN IMI LITECAST™

Exterior Dimensions: 62W x 38D

Note: Base dimensions may vary +/- 1/8"

* Also available in IMI ProCast™

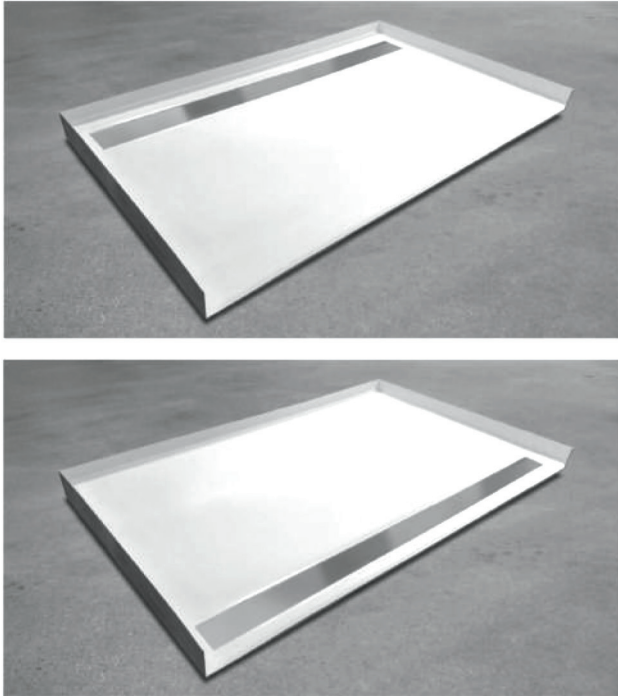

Material to be stacked on pallets.

DRAIN FINISHES

Solid Cover	Code
Brushed Stainless Steel	SS
Ornamental (Slotted)	OSS
Decorative (Perforated)	DSS
Powder Coated	W, MB

COLOR & TRIM OPTIONS

Standard Color	Code
White	SW

Optional Color	Code
Cream	SC
Ivory	SI
Warm White	WW

Additional custom colors available.

FEATURES

- Fiberglass Flange
- Front or rear drain
- Pre-sloped to drain
- Solid one-piece construction
- Pre-leveled, rests on subfloor
- Mold and mildew resistant
- Bacteria resistant
- "Grout-free" and non-porous
- Stain resistant and easy to clean
- Waterproof and leakproof

OPTIONS

- 8" x 72" x 1 1/2" Access Ramp (Trim to Fit)

STANDARDS AND RATINGS

- Typical CSI Code: 22 42 23 (Div 22)
- ANSI
- ASTM (Fire Rating)
- MAS Certified Green

Code compliant when fully equipped and installed according to guidelines.



Cast Marble Solutions



SB62x38-RI-5TD-LC

62 X 38 ADA ROLL-IN W/5" TRENCH DRAIN
IMI LITECAST™

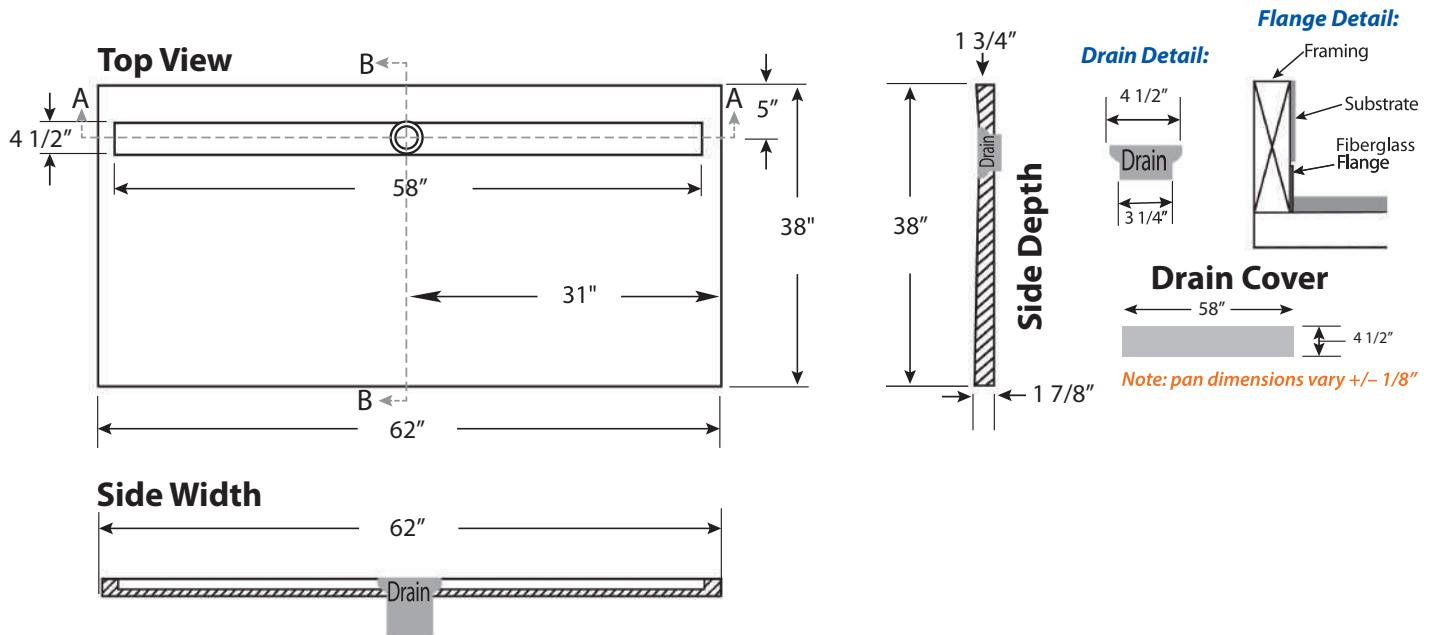

FEATURES Dimensional Tolerance $\pm 1/8"$. Dimensions needed for site preparation should be measured from the unit. American Bath Group assumes no responsibility for preparatory work.

Type and Model #	Material	Shower Base	Pieces
Shower Base #SB62x38-RI-5TD-LC	Cast Marble	Anti-Slip/Textured Finish	1

DIMENSIONS

Specifications	inches
Shower Base Depth:	38
Shower Base Width:	62
Threshold Height:	1 3/4

Suggested Drains:



Solvent Weld type fitting similar to Oatey Part No. 42097



Compression type "No-Caulk" fitting similar to Oatey Part No. 42099

Rev. 02.01.21